

blue
performance

COLLECTION 2018



COMFORT ◦ STORAGE ◦ PROTECTION ◦ PERFORMANCE

A few years ago, a group of designers with a great deal of sailing experience got together with a team of marketing professionals and decided to work on a series of new products: innovative products for sailing yachts and motor boats that can be used for storage, for increasing comfort and for protecting valuables. Blue Performance stands for boating equipment and accessories designed with the greatest of care. The products are functional, durable, extensively tested and always designed in harmony with each other. At the introduction of the first series of products at the largest international watersport trade fair, the products were immediately received with favour by the specialist trade and consumers. Everybody has embraced the new brand and the products have been given various design awards. Thanks to continuous innovation, we are developing new products to the assortment and improving existing products. Blue Performance stands for Comfort, Storage and Protection. Handy and durable products, in the harbour or on the water.

We hope you enjoy using the products that we have developed for you.

Team Blue Performance



PRODUCT LINES



Comfort

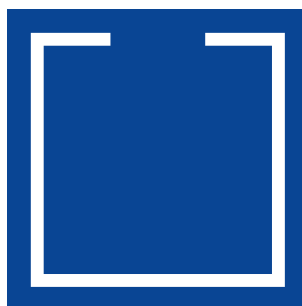

Storage



Protection

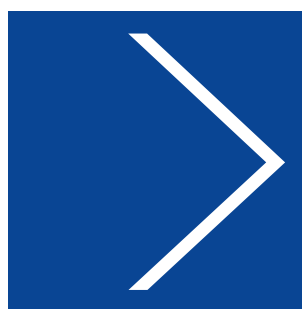

Performance

PACKAGING



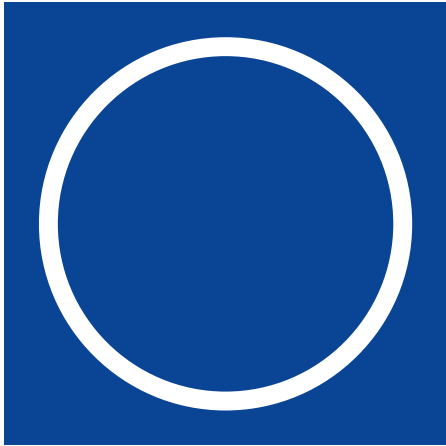

Comfort







HAMMOCK WITH FORESTAY SUSPENSION

Superior design gives this hammock its marine credentials.

Features

- Mesh centre panel for cool comfort
- Reinforced hem for durability
- Webbing panels for strength

Easy to Use

- 1 Attach one end of the hammock to the spinnaker pole ring on the mast (or a halyard) using the softshackle supplied.
- 2 On the other end, a saddle folds around the forestay (or attach it to a genoa halyard and fix this to the toe rail with a short rope).
- 3 Relax.

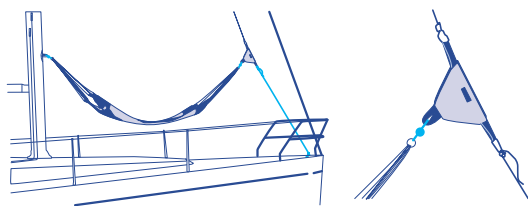

Code	Dimensions (L x W)	
	mm	inches
BP190	2100 x 1200/1000	82.7 x 47.2/39.4



BUNK NET

Just the thing to stop you rolling out of bed or store equipment in rough weather.

Features

- Ripstop nylon reinforced with nylon webbing and polyester borders
- Two mesh everyday bags, perhaps for glasses and a watch
- 170cm x 53cm with 37cm straps on the bottom edge

Easy to Use

- 1 Bunk Net features five equally spaced straps hanging from the bottom edge. These tuck under the mattress and can be screwed down through the conveniently spaced drill holes.
- 2 At night, tie the Bunk Net D-rings to the cabin sides and in the morning stow it under the mattress.

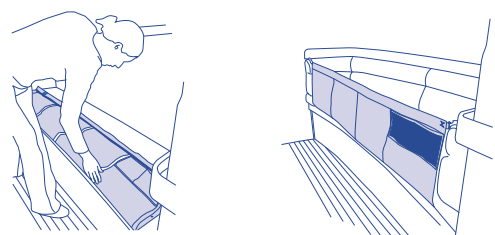

Code	Dimensions (L x H)	
	mm	inches
BP600	1700 x 530 + 370	66.9 x 20.9 + 14.6



SEA RAIL COVER

Sea rail covers make hiking out or leaning on the rails more comfortable.

Features

- Outer cover of Blue Performance Ripstop with Velcro closure over the full length
- Mid-layer of durable foam
- Inner core of clear flexible plastic tube, spiral cut, to protect the foam mid-layer

Easy to Use

- 1 Thread the wire of the rail through the inner core and foam mid-layer.
- 2 Fit the Ripstop cover over the foam mid-layer.
- 3 Fasten each end of the cover with a draw string to prevent sliding.

Code	Size	Dimensions (L)	
		m	feet
BP865	STANDARD	1	3.3
BP866	LONG	1.5	4.9
BP867	EXTRA LONG	2.0	6.6



RAILING CUSHION

Lean comfortably against the guard rail with a padded railing cushion.

Features

- Thick foam
- Water repellent Ripstop
- Install as in picture or upside down

Easy to Use

Four Velcro straps attach to the rail

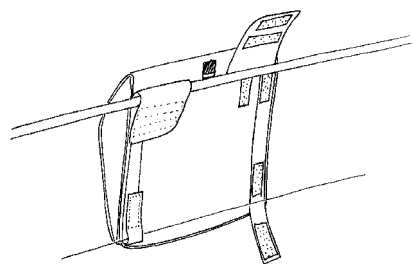

Code	Dimensions (L x H x D)	
	mm	inches
BP898	440 x 420 x 105	173.2 x 165.4 + 41.3

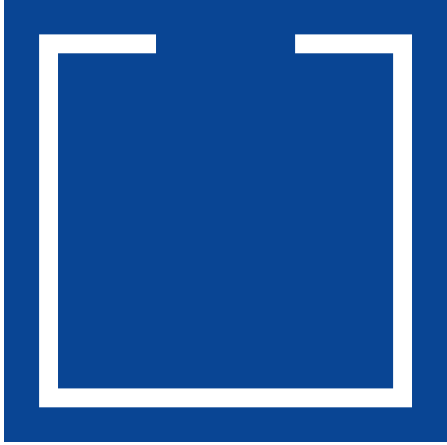

Storage

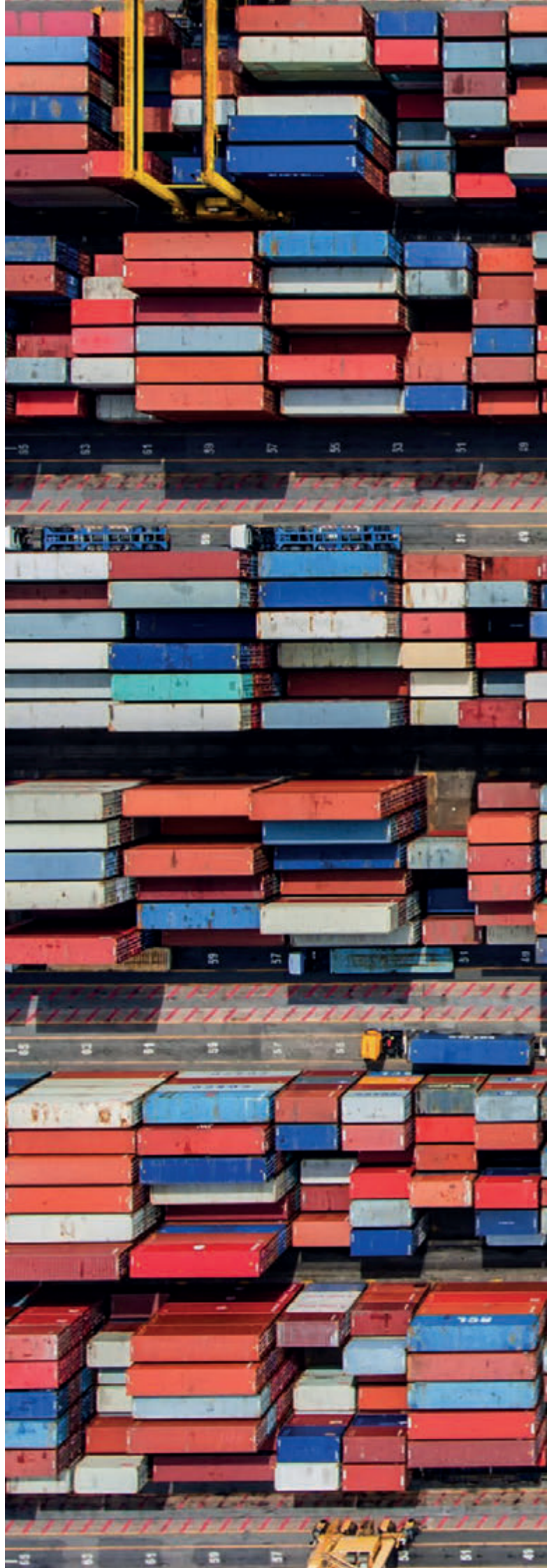

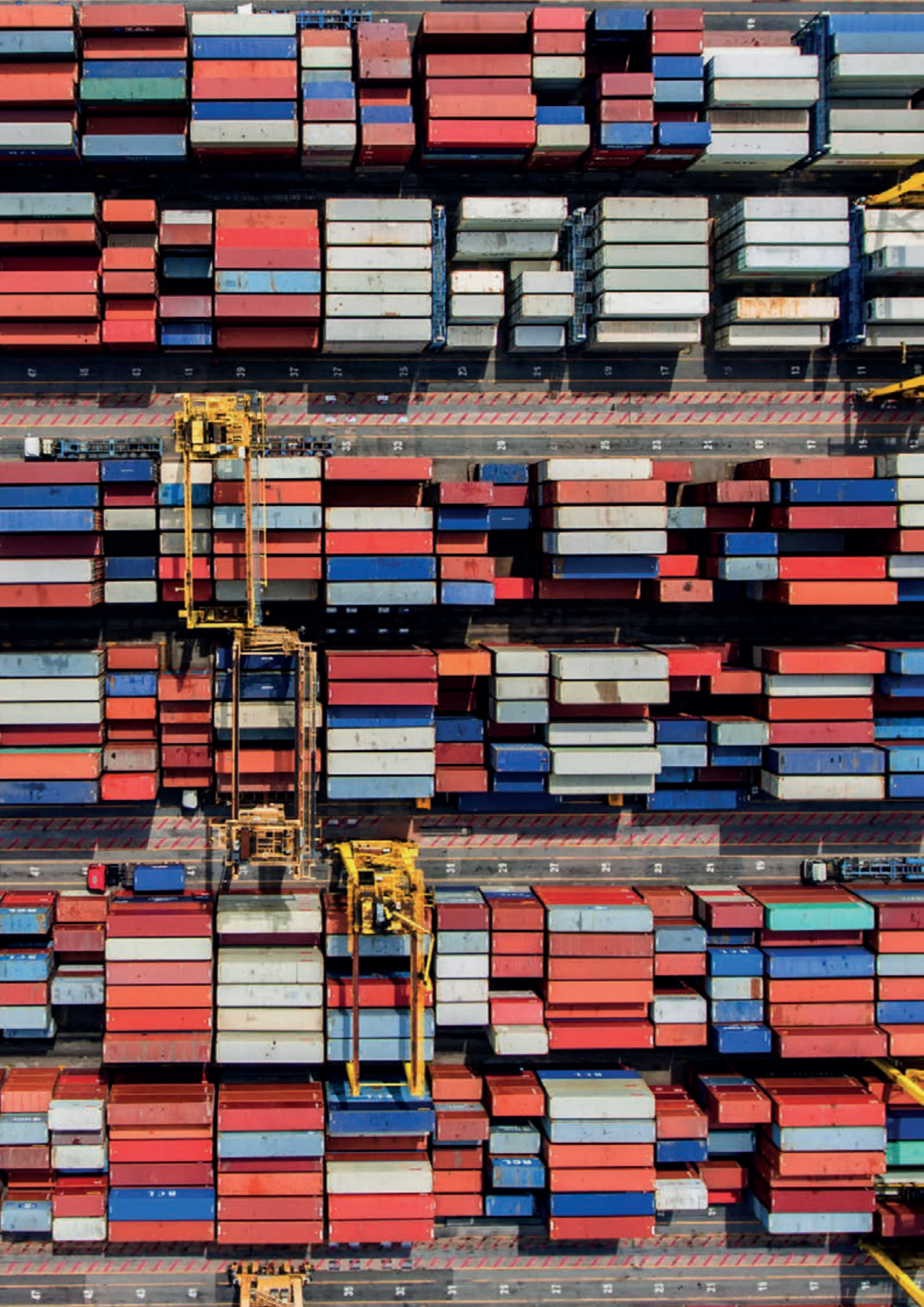



COCKPIT BAG
SMALL

Store your drinks, sun cream, etc. in this handy storage bag.

Features

- Attach and remove using Blue Performance screw-in hooks
- Flap with Velcro closure
- Waterproof, mildew and UV resistant material
- Ripstop lining

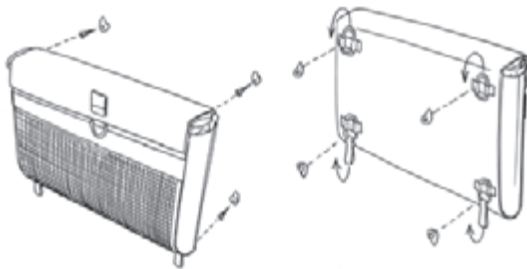

Code	Size	Dimensions (W x H x D)	
		mm	inches
BP3410	SMALL	300 x 200 x 50	11.8 x 7.9 x 2.0



COCKPIT BAG
MEDIUM

Store your drinks, sun cream, etc. in this handy storage bag.

Features

- Attach and remove using Blue Performance screw-in hooks
- Flap with Velcro closure
- External front pocket with mesh
- Waterproof, mildew and UV resistant material
- Ripstop lining

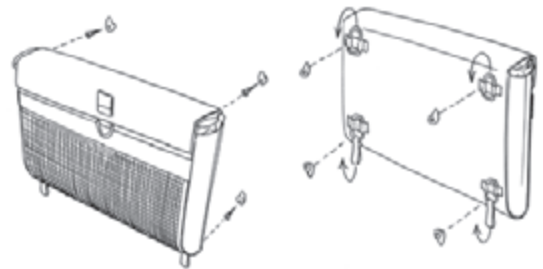

Code	Size	Dimensions (W x H x D)	
		mm	inches
BP3415	MEDIUM	350 x 260 x 50	13.8 x 10.2 x 2.0



COCKPIT BAG LARGE

Store your drinks, sun cream, etc, in this handy storage bag.

Features

- Attach and remove using Blue Performance screw-in hooks
- Flap with Velcro closure
- Double external front pockets with mesh
- Two inner pockets
- Waterproof, mildew and UV resistant material
- Ripstop lining

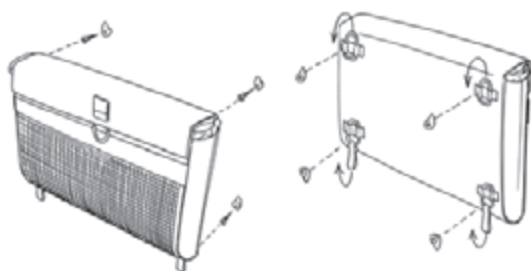

Code	Size	Dimensions (W x H x D)	
		mm	inches
BP3400	LARGE	470 x 300 x 50	18.5 x 11.8 x 2.0



COCKPIT BAG COMBI

Store your winch handle, drinks, sun cream, etc, in this handy storage bag.

Features

- Attach and remove using Blue Performance screw-in hooks
- Flap with Velcro closure
- External front pocket with mesh
- Two external winch handle bags/bottle holders
- Two inner pockets
- Waterproof, mildew and UV resistant material
- Ripstop lining

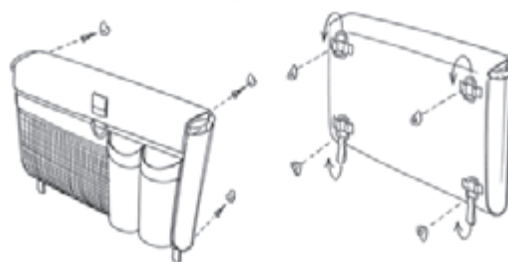

Code	Size	Dimensions (W x H x D)	
		mm	inches
BP3405	COMBI	470 x 300 x 70	18.5 x 11.8 x 2.8



BULKHEAD SHEET BAG WITH INTEGRATED RAINCOVER

Store your halyards & sheets in this handy storage bag.



Features

- Attach and remove using Blue Performance screw-in hooks
- One compartment
- Mesh side pannels
- Waterproof, mildew and UV resistant material
- Ripstop lining
- An integrated pocket in the base contains a waterproof cover manufactured from UV resistant Ripstop

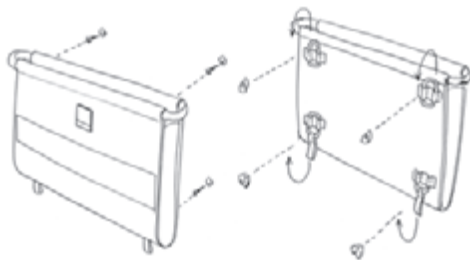

Code	Size	Dimensions (W x H x D)	
		mm	inches
BP3450	SMALL	300 x 200 x 70	11.8 x 7.9 x 2.8
BP3460	MEDIUM	350 x 250 x 70	13.8 x 9.8 x 2.8
BP3470	LARGE	400 x 300 x 70	15.7 x 11.8 x 2.8
BP3475	DEEP	350 x 400 x 70	13.8 x 15.7 x 2.8



BULKHEAD SHEET COMBI BAG WITH INTEGRATED RAINCOVER

Store your winch handle, drinks, sun cream, etc, in this handy storage bag.



Features

- Attach and remove using Blue Performance screw-in hooks
- Three compartments with mesh bottom
- Mesh front pouch
- Waterproof, mildew and UV resistant material
- Ripstop lining
- An integrated pocket in the base contains a waterproof cover manufactured from UV resistant Ripstop

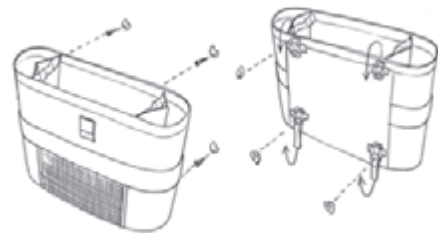

Code	Size	Dimensions (W x H x D)	
		mm	inches
BP3500	SMALL	350 x 250 x 100	13.8 x 9.8 x 3.9
BP3505	MEDIUM	385 x 275 x 110	15.2 x 10.8 x 4.3
BP3510	LARGE	420 x 300 x 120	16.5 x 11.8 x 4.7



SEA RAIL BAG STANDARD WITH INTEGRATED RAINCOVER

Store your sheets in this handy sea rail bag.



Features

- Attach to the wire/rail using a Velcro flap and fix upright with two webbing straps on the lower wire/rail
- Inner pocket with closure
- Mesh side pannels
- Waterproof, mildew and UV resistant material
- Ripstop lining
- An integrated pocket in the base contains a waterproof cover manufactured from UV resistant Ripstop

SEA RAIL BAG DELUXE

Store your winch handle, drinks, sun cream, etc, in this handy sea rail bag.

Features

- Attach to the wire/rail using a Velcro flap and fix upright with two webbing straps on the lower wire/rail
- Flap with Velcro closure
- Inner pocket with closure
- Two side compartments
- Waterproof, mildew and UV resistant material
- Ripstop lining

Code	Size	Dimensions (W x H x D)	
		mm	inches
BP3490	MEDIUM	350 x 250 x 70	13.8 x 9.8 x 2.8
BP3495	LARGE	400 x 320 x 70	15.7 x 12.6 x 2.8

Code	Size	Dimensions (W x H x D)	
		mm	inches
BP3515	MEDIUM	350 x 250 x 70	13.8 x 9.8 x 2.8
BP3520	LARGE	400 x 320 x 70	15.7 x 12.6 x 2.8



WINCH HANDLE BAG

Store your winch handle in this handy winch handle bag.

Features

- Plastic reinforcement holds the shape
- Stores up to three winch handles in size large
- Self draining
- Waterproof, mildew and UV resistant material
- Reinforced lining

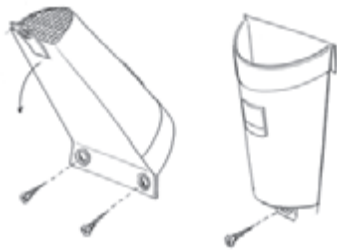

Code	Size	Dimensions (W x H x D)	
		mm	inches
BP3435	SMALL	240 x 90 x 70	9.4 x 3.5 x 2.8
BP3440	LARGE	240 x 120 x 100	9.4 x 4.7 x 3.9



CABIN BAG

SMALL

Great for phones, tablets, CD's and books.

Features

- Attach and remove using Blue Performance screw-in hooks
- One large lower pocket
- Two small upper pockets
- Waterproof, mildew and UV resistant material
- Ripstop lining

CABIN BAG

LARGE



Additional features

- Three small pockets instead of two
- Two mesh bags

Code	Size	Dimensions (W x H x D)	
		mm	inches
BP3580	SMALL	350 x 470 x 70	13.8 x 18.5 x 2.8
BP3585	LARGE	450 x 580 x 70	17.7 x 22.8 x 2.8



CAN HOLDER
RAILING

Store your drinks at the rail.

Features

- Attach the Velcro flap to the wire/rail and hold upright with two webbing tail straps around the lower wire/rail.
- Holds for two cups, cans or bottles
- Stylish reinforcement around the opening ensures durability
- Self draining
- Waterproof, mildew and UV resistant material



CAN HOLDER
WITH HOOKS

Store your drinks in this handy holder.

Features

- Attach and remove using Blue Performance screw-in hooks
- Holds for two cups, cans or bottles
- Stylish reinforcement around the opening ensures durability
- Self draining
- Waterproof, mildew and UV resistant material

Code	Dimensions (W x H x D)	
	mm	inches
BP3660	180 x 100 x 90	7.1 x 3.9 x 3.5

Code	Dimensions (W x H x D)	
	mm	inches
BP3661	215 x 130 x 90	8.5 x 5.1 x 3.5



DINGHY COCKPIT BAG

Store your lunch, drinks, sun cream, etc, in this handy storage bag. Specially developed for Laser and Optimist type of boats.

Features

- A large, lined canvas bag with Velcro flap
- A pocket on top for a waterbottle
- Waterproof, mildew and UV resistant PVC
- Install with provided self-adhesive Velcro or with a lanyard attached to the loops at the back



STORAGE RAIL BAG

Premium bags, secured on the rail with plenty of storage space.

Features

- Storage Rail Bags sit on deck attached to the rail using Velcro and wire rail clips
- Waterproof, mildew and UV resistant Ripstop
- Plastic reinforcement maintains the bag's semi circular shape
- Clip down cover
- Self draining

Code	Size	Dimensions (L x W x D)	
		mm	inches
BP779	LARGE	195 x 210 x 135	7.7 x 8.3 x 5.3
BP780	SMALL	190 x 150 x 110	7.5 x 5.9 x 4.3
BP781	LARGE BLACK	195 x 210 x 135	7.7 x 8.3 x 5.3
BP782	SMALL BLACK	190 x 150 x 110	7.5 x 5.9 x 4.3

Code	Size	Dimensions (L x H x D)	
		mm	inches
BP615	MEDIUM	750 x 585 x 375	29.5 x 23.0 x 14.8
BP620	LARGE	900 x 585 x 450	35.4 x 23.0 x 17.7

**THIS PRODUCT IS ONLY AVAILABLE FROM OUR WAREHOUSE IN THE NETHERLANDS

**THIS PRODUCT IS ONLY AVAILABLE FROM OUR WAREHOUSE IN THE NETHERLANDS





SEA MAP BAG

Protect your charts from splashes and tears.

Features

- Protects your charts from splashes and tears
- See trough on both sides
- Padded flap with Velcro closure



HALYARD BAG

Store your halyards at the mast in this handy bag.

Features

- Storage for up to three mast-head halyards
- Velcro mast straps
- Self draining
- Waterproof, mildew and UV resistant Ripstop
- Three hanging rope clips inside the bag to separate halyards
- Heavy duty zip front with Velcro flap
- Open collar at the top for halyard entry

Code	Size	Dimensions (W x H)	
		mm	inches
BP485	SMALL**	360 x 500	14.2 x 19.7
BP480	LARGE	450 x 700	17.7 x 27.6

Code	Size	Dimensions (W x H x D)	
		mm	inches
BP550	SMALL	150 x 450 x 110	5.9 x 17.7 x 4.3
BP555	MEDIUM	175 x 600 x 130	6.9 x 23.6 x 5.1
BP560	LARGE	210 x 700 x 150	8.3 x 27.6 x 5.9

**THIS PRODUCT IS ONLY AVAILABLE FROM OUR WAREHOUSE IN THE NETHERLANDS





SAIL CLIPS

3 PIECE SET

Tie your main to the boom. Attention to detail make these sail ties the best you can get.

Features

- The webbing sleeve design features integral shock cord to gather the sail after clipping
- Clip size is printed on the buckle padding and colour coded on its end
- Easy to use
- Each Sail Clip has a quick release, slide adjustable buckle



ROPE CLIPS

PAIR

Tidy storage for ropes, garden hoses and extension cords. Also handy in and around the house.

Features

- The loop is reinforced by a cord threaded through the tube
- Tags on the loop assist easy release
- Mildew and UV resistant webbing

Easy to Use

- 1 On installation, screw the Rope Clip in place.
- 2 Once fitted, pass the strap through the rope coil and clip the loop over the screwed fitting.
- 3 Adjust the webbing length with a slide buckle

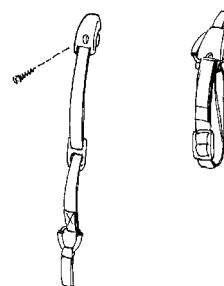

Code	Size	Dimensions (∅)	
		mm	inches
BP290	EXTRA SMALL	140 - 240	5.5 - 9.4
BP300	SMALL	220 - 340	8.7 - 13.4
BP310	MEDIUM	280 - 470	11.0 - 18.5
BP320	LARGE	360 - 590	14.2 - 23.2
BP330	MIX S/M/L	-	-

Code	PAIR	Dimensions (L)	
		mm	inches
BP340	PAIR	220 - 320	8.7 - 12.6





Protection







SUNSHADE FREE HANGING

Suspend this sunshade from a halyard anywhere you like on a yacht.

Features

- Assemble and pack away in a minute
- Stows in its own compact bag
- Waterproof, Ripstop, reflective material provides UV protection
- Centre grommet for hanging
- Flexible batten sections
- Reinforced with webbing and polyester hem

Easy to Use

- 1 Unpack the sunshade and batten sections.
- 2 Guide the battens through loops and seat in each corner.
- 3 Suspend the sunshade from its centre ring with a halyard.
- 4 Fix its position using the corner cords attached to the railing.

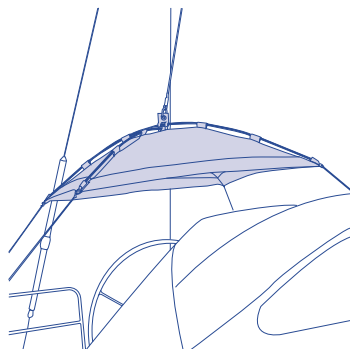

Code	Size	Dimensions (L x W)	
		mm	Inches
BP150	SMALL	1020 x 1020	40.2 x 40.2
BP160	MEDIUM	1370 x 1370	53.9 x 53.9
BP170	LARGE	1600 x 1600	63.0 x 63.0
BP180	GIANT	2000 x 2000	78.7 x 78.7



DECK SUNSHADE

Suspend this sunshade from a halyard over the deck of a yacht.

Features

- Assemble and pack away in a minute
- Stows in its own compact bag
- Waterproof, Ripstop, reflective material provides UV protection
- Reinforced with webbing and polyester hem

Easy to Use

- 1 Unpack the sunshade and hold the centre D-ring at the rear side.
- 2 Attach the halyard to the D-ring.
- 3 Attach the ropes to the railing to position the deck sunshade.
- 4 Pull up the halyard to suspend the deck sunshade.

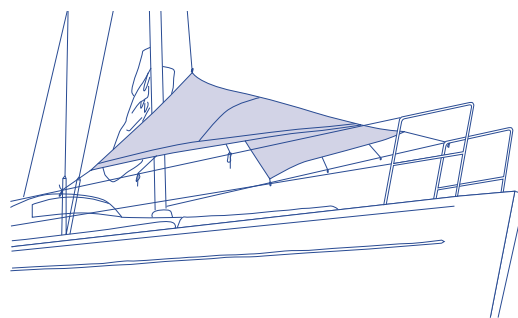

Code	Size	Dimensions (W1 x L x W2)	
		mm	feet
BP200	SMALL	1800 x 1800 x 39	5.9 x 5.9 x 1.3
BP201	MEDIUM	2300 x 2300 x 53	7.5 x 7.5 x 1.7
BP202	LARGE	2800 x 2900 x 60	9.2 x 9.5 x 2.0
BP203	EXTRA LARGE	3250 x 3550 x 60	10.7 x 11.6 x 2.0

**THIS PRODUCT IS ONLY AVAILABLE FROM OUR WAREHOUSE IN THE NETHERLANDS





AWNING STANDARD

Attention to detail make this the easiest of awnings to put up.

Features

- Waterproof, Ripstop, reflective material provides UV and rain protection
- Port and starboard coloured reinforcement
- Reinforced with webbing

Easy to Use

- 1 Throw the awning over the boom.
- 2 Clip two buckle ties sewn on the inside ridge around the boom.
- 3 Secure the ridge to the mast with an adjustable webbing buckle.
- 4 Pass the two sides of the cockpit section around the topping lift and Velcro them together at the ridge.
- 5 Tie the ridge to the back stay with the cord provided.
- 6 Secure the edges and corners with adjustable webbing ties.

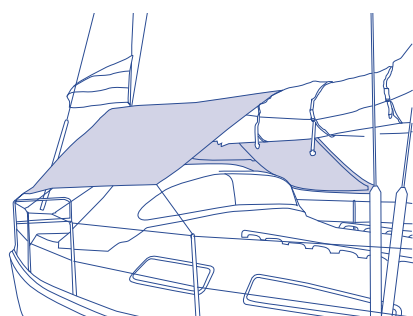

Code	Size	Dimensions (L x W)	
		mm	feet
BP101	SMALL	3000 x 2600	9.8 x 8.5
BP111	MEDIUM	3300 x 2850	10.8 x 9.4
BP121	LARGE	3600 x 3100	11.8 x 10.2



AWNING DELUXE

Attention to detail make this the easiest of awnings to put up.

Features

- Waterproof, Ripstop, reflective material provides UV and rain protection
- Port and starboard coloured reinforcement
- Reinforced with polyester hem
- Ventilation opening

Easy to Use

- 1 Throw the awning over the boom.
- 2 Clip two buckle ties sewn on the inside ridge around the boom.
- 3 Secure the ridge to the mast with an adjustable webbing buckle.
- 4 Pass the two sides of the cockpit section around the topping lift and Velcro them together at the ridge.
- 5 Tie the ridge to the back stay with the cord provided.
- 6 Secure the edges and corners with adjustable webbing ties.

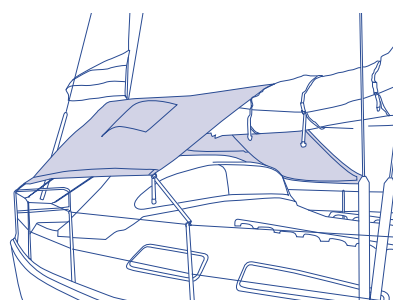

Code	Size	Dimensions (L x W)	
		mm	feet
BP102	SMALL	3000 x 2600	9.8 x 8.5
BP112	MEDIUM	3300 x 2850	10.8 x 9.4

**THIS PRODUCT IS ONLY AVAILABLE FROM OUR WAREHOUSE IN THE NETHERLANDS







WINCH COVER

Winch covers shield winches from the corrosive effects of the sun and salt water.

Features

- Tough Ripstop fabric with reinforced interior and rim
- Weatherproof and UV resistant
- Two air vents prevent condensation and mildew
- Three, sprung clips inside the cover fix it to the winch
- Compatible with Anderson, Lewmar and Harken winches

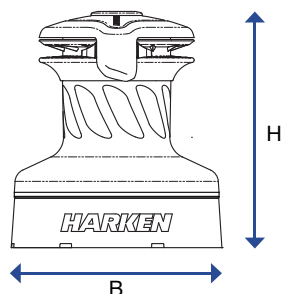

Code	Size	B		H	
		in mm		in inches	
BP901	1	156	151	6.1	5.9
BP902	2	165	173	6.5	6.8
BP903	3	156	176	6.1	6.9
BP904	4	168	196	6.6	7.7
BP905	5	189	222	7.4	8.7
BP906	6	203	250	8.0	9.8
BP907	7	213	270	8.4	10.6
BP908	8	224	205	8.8	8.1
BP909	9	254	266	10.0	10.5
BP921	10.1	273	280	10.8	11.0
BP922	10.2	318	315	12.5	12.4
BP912	12*	324	330	12.8	13.0
BP913	13*	356	360	14.0	14.2

*SIZES 11,12 & 13 ARE ONLY AVAILABLE FROM OUR WAREHOUSE IN THE NETHERLANDS

Size	Description	Type	H		B	
			in mm		in inches	
1	Harken Radial	15ST	139	120	5.5	4.7
1	Harken classic	16PT	120	112	4.7	4.4
1	Lewmar Ocean	16PT	120	112	4.7	4.4
1	Lewmar EVO	16PT	120	112	4.7	4.4
1	Lewmar EVO	15ST	121	119	4.8	4.7
1	Andersen	28PT	124	126	4.9	5.0
1	Lewmar Ocean	30PT	136	128	5.4	5.0
1	Harken Radial	20PT	137	128	5.4	5.0
1	Harken classic	32PT	139	134	5.5	5.3
2	Harken classic	16ST	120	142	4.7	5.6
2	Andersen	18ST	120	136	4.7	5.4
2	Lewmar Ocean	16ST	121	145.5	4.8	5.7
2	Andersen	28ST	125	151	4.9	5.9
2	Andersen	40PT	136	140	5.4	5.5
2	Harken Radial	20ST	137	148	5.4	5.8
2	Lewmar EVO	30PT/ST	138	145.8	5.4	5.7
2	Andersen	46PT	143	140	5.6	5.5
2	Harken classic	40PT	145	148	5.7	5.8
2	Lewmar Ocean	40PT	148	141.5	5.8	5.6
2	Harken Radial	35PT	149	148	5.9	5.8
2	Lewmar Ocean	44PT	167	151	6.6	5.9
3	Lewmar Ocean	30ST	138	160.5	5.4	6.3
3	Harken classic	32ST	139	164	5.5	6.5
3	Lewmar EVO	40PT/ST	148	158.5	5.8	6.2
3	Harken Radial	35ST	149	170	5.9	6.7
3	Harken Radial	40PT	157	153	6.2	6.0
4	Lewmar Ocean	40ST	148	173	5.8	6.8
4	Harken classic	40ST	152	176	6.0	6.9
4	Andersen	40ST	152	174	6.0	6.9
4	Harken Radial	40ST	157	175	6.2	6.9
4	Harken classic	42PT	165	162	6.5	6.4
4	Lewmar Ocean	46ST	168	192	6.6	7.6
4	Lewmar EVO	45ST	168	177.7	6.6	7.0
5	Harken classic	44ST	172	196	6.8	7.7
5	Harken classic	46ST	176	210	6.9	8.3
5	Andersen	46/48ST	180	209	7.1	8.2
5	Lewmar Ocean	48ST	181	208	7.1	8.2
5	Lewmar EVO	50ST	181	197	7.1	7.8
5	Harken Radial	46PT	184	179	7.2	7.0
5	Harken Radial	46ST	184	201	7.2	7.9
5	Harken classic	48PT	187	192	7.4	7.6
5	Harken Radial	50PT	194	190	7.6	7.5
5	Harken Radial	50ST	194	206	7.6	8.1
6	Harken classic	48ST	189	222	7.4	8.7
7	Lewmar Ocean	50ST	200	238	7.9	9.4
7	Andersen	52ST	200	228	7.9	9.0
7	Lewmar EVO	55ST	205	233	8.1	9.2
8	Lewmar Ocean	54ST	205	250	8.1	9.8
8	Harken classic	53ST	221	245	8.7	9.6
8	Lewmar Ocean	58ST	228	231	9.0	9.1
8	Lewmar EVO	65ST	228	251	9.0	9.9
9	Harken classic	60ST	225	270	8.9	10.6
9	Andersen	58/62ST	230	257	9.1	10.1
9	Lewmar Ocean	65ST	231	248	9.1	9.8
9	Harken Radial	60ST	232	246	9.1	9.7

FOR OTHER WINCH SIZES PLEASE REFER TO WINCHCOVER DIMENSIONS





FURLED HEADSAIL COVER

Protect your headsail from the sun and sea.

Features

- Water repellent
- Very high UV-resistant material
- Breathable material allows moist to evaporate
- YKK-zipper with plastic runner which do not corrode
- Fits around the drum of the furler
- Standard length can be increased up to 1.5m, in steps of 15cm with the use of the extension piece
- The cover is divided in three sections, each with their own drawcord for ease of tensioning
- The fairleads of the upper section are provided with a sheave to reduce friction

Code	Size	Dimensions (L)	
		m	feet
BP2011	SMALL	11	36
BP2012	MEDIUM	12.5	41
BP2013	LARGE	14	46
BP2019	EXTENSION	1.5	4.9

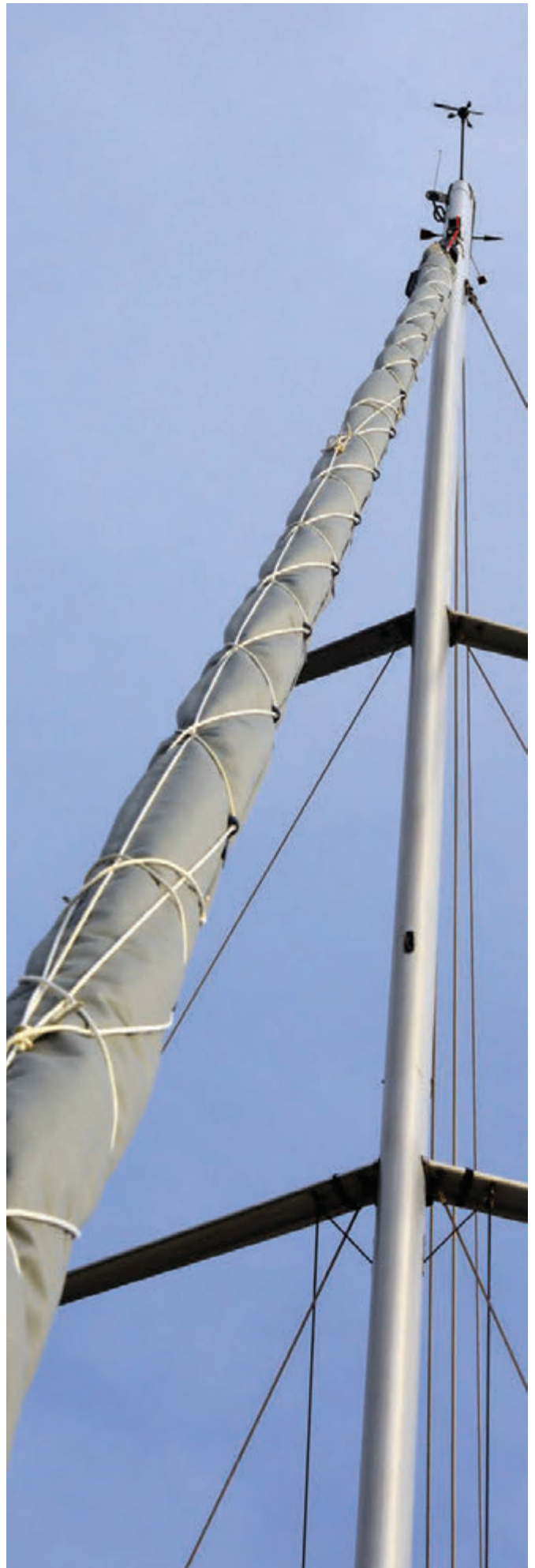



MAINSAIL COVER

Protect your mainsail from the sun and sea.

Features

- Water repellent
- Very high UV-resistant material
- Breathable material allows moist to evaporate
- Standard length can be increased with provided aft section

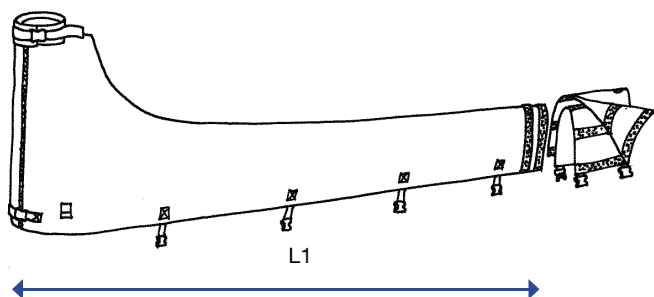

Code	Size	Dimensions (L1 - L2 x H)	
		m	feet
BP1011	1	2.9 - 3.3 x 1.24**	9.5 - 10.8 x 4.1**
BP1012	2	3.3 - 3.7 x 1.30**	10.8 - 12.1 x 4.3**
BP1013	3	3.7 - 4.1 x 1.37**	12.1 - 13.5 x 4.5**
BP1014	4	4.1 - 4.5 x 1.48**	13.5 - 14.8 x 4.9**



STEERING WHEEL COVER

Protects your steering wheel.

Features

- Waterproof, mildew and UV resistant Ripstop
- Slides over steering wheel and closes with Velcro
- Neoprene steeringshaft protector

Code	Size	Dimensions (ø)	
		mm	inches
BP757	1	515	20,3
BP759	3	615	24,2
BP766	4	670	26,4
BP767	5	715	28,1
BP768	6	820	32,3
BP769	7	860	33,9
BP770	8	920	36,2
BP772	10	1120	44,1
BP773	11	1225	48,2
BP774	12	1330	52,4
BP795	13	1410	55,5
BP797	15	1620	63,8

**THIS PRODUCT IS ONLY AVAILABLE FROM OUR WAREHOUSE IN THE NETHERLANDS

**THIS PRODUCT IS ONLY AVAILABLE FROM OUR WAREHOUSE IN THE NETHERLANDS





UNIVERSAL COVER

A multitude of uses includes a hatch cover for wet weather, blinds for hatches or a sunshade.

Features

- Waterproof, mildew and UV resistant Rip stop
- Comes complete with corner guys

Easy to Use

- 1 Unpack the universal cover.
- 2 Place the universal cover over the designated position.
- 3 Fix the universal cover on all sides with the cords provided.

Code	Size	Dimensions (L x W)	
		mm	inches
BP915	STANDARD	900 x 900	35.4 x 35.4



STAY PROTECTION

A cover for the stay rigging screws to protect ropes, sails and the crew.

Features

- Waterproof, mildew and UV resistant PVC
- Velcro fixture

Use

- BP890 for 5/16" & 3/8" turnbuckles
 BP891 for 7/16" & 1/2" turnbuckles
 BP892 for 5/8" & 3/4" turnbuckles

Code	Size	Dimensions (L x W)	
		mm	inches
BP890	SMALL	370 x 75	14.6 x 3.0
BP891	MEDIUM	475 x 95	18.7 x 3.7
BP892	LARGE	610 x 135	24.0 x 5.3

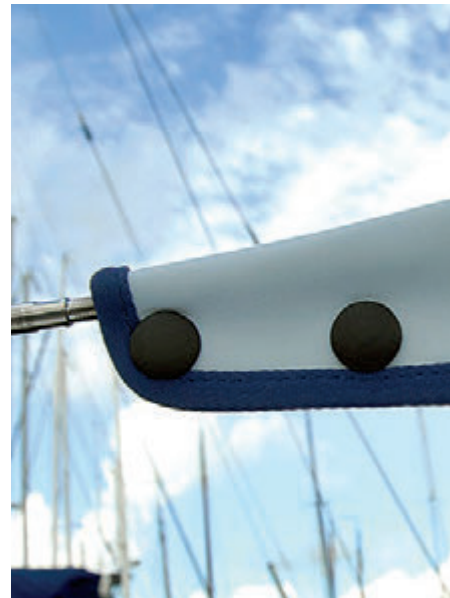

SEA RAIL PROTECTOR

A smart cover over the lifeline fittings to avoid snags.

Features

- Waterproof, mildew and UV resistant PVC
- Easy to install and remove
- Fastens with push buttons

Code	Size	Dimensions (L x ø1 x ø2)	
		mm	inches
BP895	MEDIUM	180 x 10 x 20	7.1 x 3.9 x 7.9
BP896	LARGE	198 x 13 x 25	7.8 x 5.1 x 9.8





HATCH COVER

Hatch covers prevent the deterioration and crazing of hatch acrylic and can provide a blind for the night.

Features

- Waterproof, mildew and UV resistant Ripstop
- Stretch border with elastic straps for a neat fit
- Secure with shock cord and toggle around the rim

ALSO AVAILABLE IN A ROUND SHAPE
BP812 & BP813

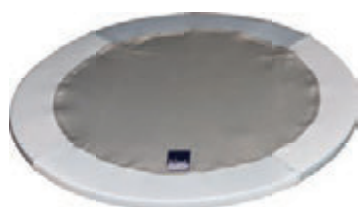

Code	Size	Dimensions (L x W)	
		Maximum hatch size mm	Maximum hatch size inches
BP801	1	280 x 280	11.0 x 11.0
BP802	2	330 x 330	13.0 x 13.0
BP803	3	450 x 450	17.7 x 17.7
BP804	4	500 x 500	19.7 x 19.7
BP805	5	580 x 580	22.8 x 22.8
BP806	6	700 x 700	27.5 x 27.5
BP807	7	770 x 770	30.3 x 30.3
BP808	8	860 x 860	33.9 x 33.9
BP809	9	300 x 400	11.8 x 15.7
BP810	10	400 x 500	15.7 x 19.7
BP811	11	450 x 580	17.7 x 22.8
BP812**	12	ø 500	ø 19.7
BP813**	13	ø 600	ø 23.6



HATCH COVER MOSQUITO

Protects your hatch with a cover and ensures your cabin stays bug free with a tailored & weighted mosquito net.

Features Hatch Cover

- Waterproof, mildew and UV resistant Ripstop
- Stretch border with elastic straps for a neat fit
- Secure cover with shock cord and toggle around the rim

Features Mosquito net

- Mosquito net stored in a zip pocket on the cover
- The mesh net allows cabin ventilation
- Lead weights sewn into the hem holds the net flush with the deck keeping creatures out of the cabin

ALSO AVAILABLE IN A ROUND SHAPE
BP859 & BP860



Code	Size	Dimensions (L x W)	
		Maximum hatch size mm	Maximum hatch size inches
BP851	1	450 x 450	17.7 x 17.7
BP852	2	500 x 500	19.7 x 19.7
BP853	3	580 x 580	22.8 x 22.8
BP854	4	700 x 700	27.5 x 27.5
BP855	5	770 x 770	30.3 x 30.3
BP856	6	860 x 860	33.9 x 33.9
BP857	7	400 x 500	15.7 x 19.7
BP858	8	450 x 580	17.7 x 22.8
BP859	9	ø 500	ø 19.7
BP860	10	ø 600	ø 23.6

**THIS PRODUCT IS ONLY AVAILABLE FROM OUR WAREHOUSE IN THE NETHERLANDS





HULL PROTECTOR

This smart hull protector will prevent the hull of your boat from being rubbed & marked by fenders which can cause matt spots on the gel-coat leading to osmosis.

Features

- Waterproof, mildew and UV resistant Ripstop
- Reinforced with nylon webbing
- Adjustable straps attach to the guard rail
- Shock cord sewn within the straps allows some give

Code	Size	Dimensions (L x W)	
		mm	feet
BP868	SMALL	2000 x 650	6.6 x 2.1
BP869	LARGE	2500 x 800	8.2 x 2.6



ROPE COVER

Chafe guard for your mooring lines.

Features

- Water repellent polyester
- 43cm long and up to 32mm round

Easy to Use

- 1 Thread the mooring rope through the cover
- 2 Keep the cover in place with Velcro straps at each end

Code		Dimensions (L x Ø)	
		mm	inches
BP341	set of 2 pieces	430 x Ø 32	16.9 x 1.3



OUTBOARD COVER

Protect your outboard from the sun and sea.

Features

- Waterproof, mildew and UV resistant breathable material
- Stylish reinforcement and elastic straps around the opening ensures a durable, snug fit
- Sewn inside the cover a mesh bag fits over the outboard and is secured using shock cord and toggle

Use

Size 1	Up to - 3.3HP
Size 2	4 – 8.8HP
Size 3	9.9 to 15HP
Size 4	20 – 25HP

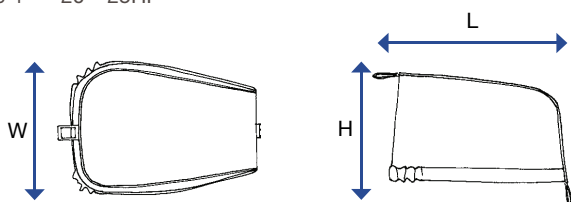

Code	Size	Dimensions (L x W x H)	
		mm	inches
BP3751	1	460 x 240 x 220	18.1 x 9.4 x 8.7
BP3752	2	480 x 280 x 300	18.9 x 11.0 x 11.8
BP3753	3	540 x 320 x 340	21.3 x 12.6 x 13.4
BP3754	4	600 x 360 x 360	23.6 x 14.2 x 14.2



GAS CYLINDER TRAY

Features

- Prevent rust marks and scratches
- Blue HDPE

Code	Dimensions (ø x H)	
	mm	inches
BP650	ø 212 x 36	ø 8.3 x 1.4

**THIS PRODUCT IS ONLY AVAILABLE FROM OUR WAREHOUSE IN THE NETHERLANDS



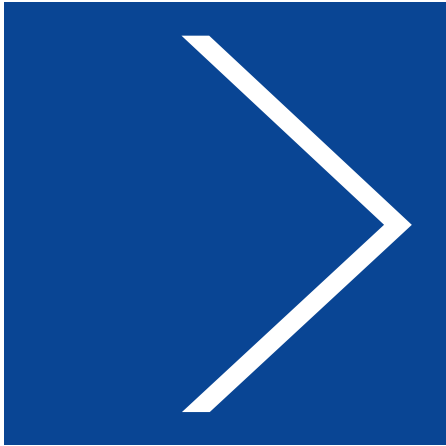

Performance







COCKPIT BAG

Store your halyards & sheets in this handy storage bag.

Features

- Waterproof, mildew and UV resistant polyester
- Self draining
- Heavy duty material
- One large expanding compartment

Code	Size	Dimensions (L x W x D)	
		mm	inches
BP2041	SMALL	350 x 300 x 120	13.8 x 11.8 x 4.7
BP2042	MEDIUM	350 x 400 x 120	13.8 x 15.7 x 4.7
BP2043	LARGE	500 x 350 x 120	13.8 x 19.7 x 4.7



SEA RAIL BAG WITH INTEGRATED RAINCOVER

Store your knife, VHF, tablet etc. in this handy sea rail bag.



Features

- Waterproof, mildew and UV resistant polyester
- Attach to the wire/rail using a Velcro flap and hold upright with two webbing straps on the lower wire/rail
- One large expanding compartment
- Self draining
- An integrated pocket in the base contains a waterproof cover

Code	Size	Dimensions (L x W x D)	
		mm	inches
BP2031	SMALL	250 x 300 x 120	9.8 x 11.8 x 4.7
BP2032	MEDIUM	350 x 420 x 120	16.5 x 13.8 x 4.7



SEA RAIL COVER

Sea rail covers make hiking out or leaning on the rails more comfortable.

Features

- Outer cover of UV resistant polyester with Velcro closure over the full length
- Mid-layer of durable foam
- Inner core of clear flexible plastic tube, spiral cut, to protect the foam mid-layer

Easy to Use

- 1 Thread the wire of the rail through the inner core and foam mid-layer.
- 2 Fit the Ripstop cover over the foam mid-layer.
- 3 Fasten each end of the cover with a draw string to prevent sliding.

Code	Size	Dimensions (L)	
		m	feet
BP2051	SMALL	1	3.3
BP2052	MEDIUM	1.5	4.9
BP2053	LARGE	2.0	6.6



WINCH HANDLE BAG

Store your winch handle in this handy winch handle bag.

Features

- Attach by using stainless steel screws
- Plastic reinforcement holds the shape
- Waterproof, mildew and UV resistant polyester
- Stores up to two winch handles
- Self draining



CREW POUCH

The Crewpouch offers a smart way of storing phones and keys that are otherwise dumped in the nav-station.

Features Crew Pouch

- Waterproof, mildew and UV resistant polyester
- Identification numbers (1-14) are included
- Soft Velcro at the back for easy installation

Features Installation Base

- The installation base holds three Crew Pouches
- Installs vertically or horizontally
- Attach by using stainless steel screws
- Plastic reinforced polyester



Installation Base for 3 pouches



Crew Pouch



WINCH COVER

Winch covers shield winches from the corrosive effects of the sun and salt water.

Features

- Tough polyester fabric
- Elasticated ridge keeps winch cover on the winch
- Waterproof, mildew and UV resistant
- Rubber handholds help placement
- Flexible design reduces storage space while sailing
- Compatible with Anderson, Lewmar and Harken winches

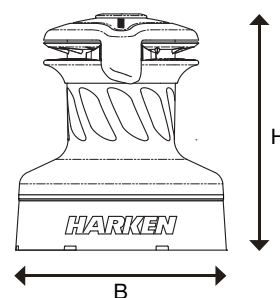

Code	Dimensions (H x W x D)	
	mm	inches
BP2021	240 x 120 x 100	9.5 x 4.7 x 3.9

Code	Size	Dimensions (L x W x H)	
		mm	inches
BP2081	POUCH	125 x 170 x 50	4.9 x 6.7 x 1.9
BP2082	BASE	210 x 420	8.3 x 16.5

Code	Size	B	H	B	H
		in mm		in inches	
BP2061	1	156	148	6.1	5.8
BP2062	2	165	148	6.5	5.8
BP2063	3	156	164	6.1	6.5
BP2064	4	168	180	6.6	7.1
BP2065	5	178	197	7.0	7.8
BP2066	6	194	213	7.6	8.4
BP2067	7	210	228	8.3	9.0
BP2068	8	211	250	8.3	9.8
BP2069	9	267	285	10.5	11.2



INSTALLATION OF BLUE PERFORMANCE COCKPIT BAGS

Blue Performance cockpit and bulkhead bags are clipped on to small white hooks screwed into the boat. Bags can be removed easily for stowage.

1 Choose the right location on board

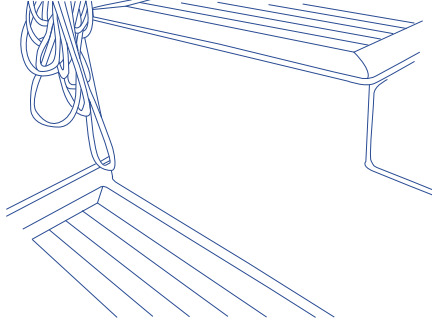

2 Using the drill pattern supplied drill four 3mm holes in the boat for each corner position.

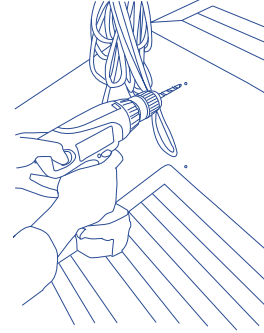

3 Screw the small white Blue Performance hooks in place, using the countersunk screws provided.

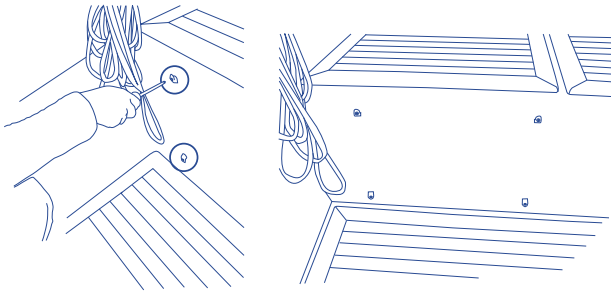

4 Place upper loops on upper hooks.

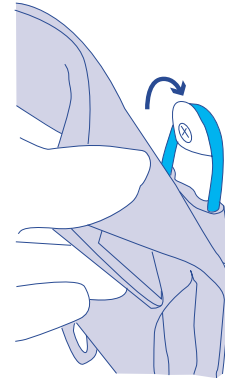

5 The back of each product has loops in each corner. Hang the top two cord loops over the hooks and stretch the two bottom elastic loops over the lower hooks.

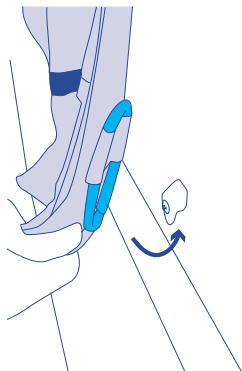

6 The elastic loops hold the bag securely in place and are tagged to assist clipping them on and off.

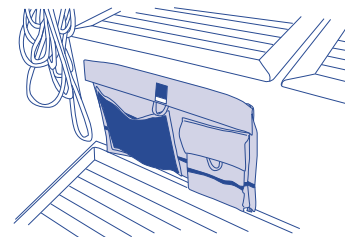

HOW TO SET UP YOUR BLUE PERFORMANCE SUNSHADE

Blue Performance Sunshades can be suspended from a halyard anywhere you like on a yacht.

1 Unpack the sunshade and batten sections.

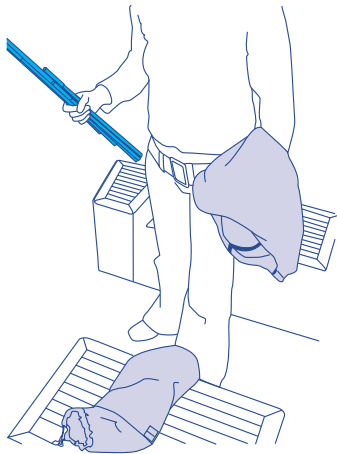

2 Assemble both battens.

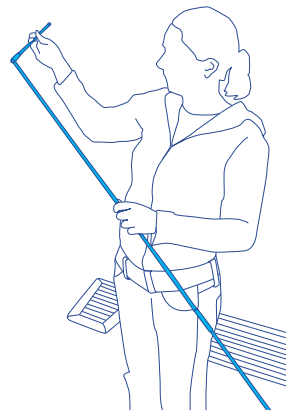

3 Guide the battens through loops and seat in each corner. Make sure the battens are crossed.

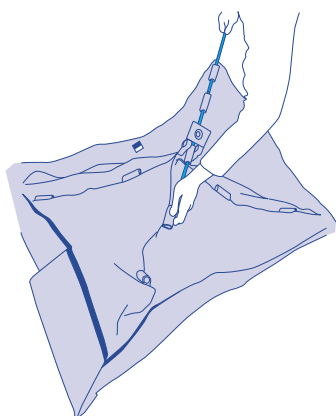

4 Tension the batten and force the tip in the corner pocket.

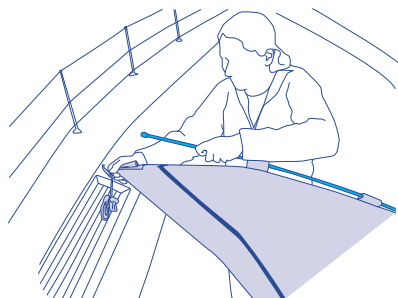

5 Suspend the sunshade from its centre ring with a halyard.

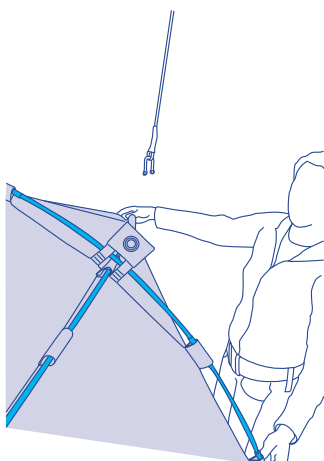

6 Fix its position using the corner cords attached to the railing.

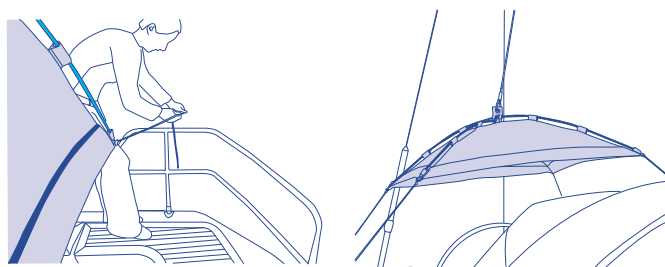

HOW TO INSTALL YOUR BLUE PERFORMANCE SAILCOVER

The Blue Performance Sailcover protects your mainsail from the sun and sea.

1 Place the cover over the mainsail.

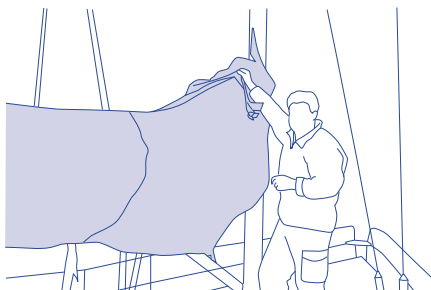

2 Pull the zipper together and close.

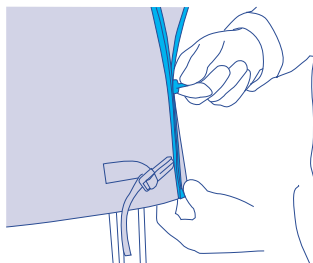

3 Fix the cover around the mast with the Velcro straps. Fasten with the buckle.

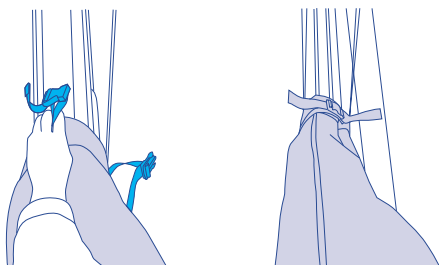

4 Define cover length to fit your boom with the separate flap at the rear. Adjust double layer of the flap and fix it with Velcro.

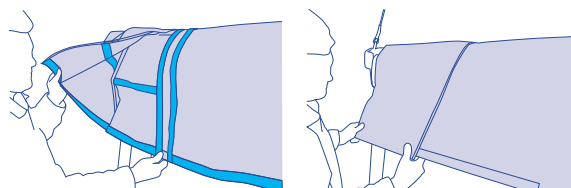

5 Attach the rear end of the cover with cord to the end of the boom.

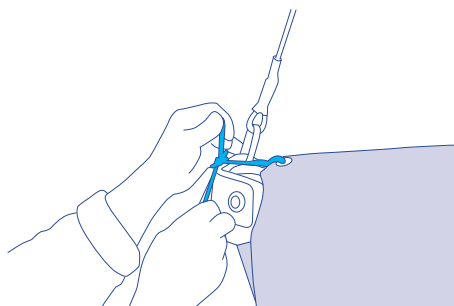

6 Fasten the cover around the sail with the buckles.

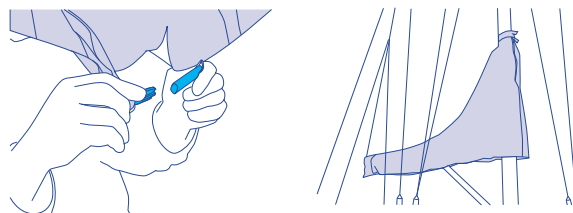

HOW TO INSTALL YOUR BLUE PERFORMANCE BUNKNET

Blue Performance bunknet keeps you from rolling out of bed in rough weather.

1 Remove the mattress.

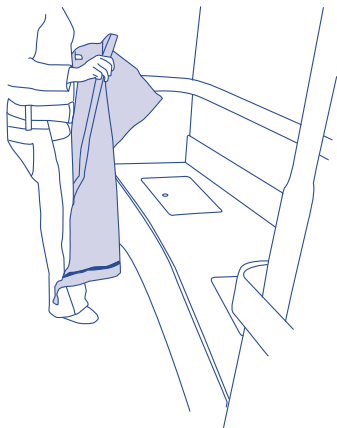

2 Place the bunknet with silver side up. Check if final height of the bunknet is ok.

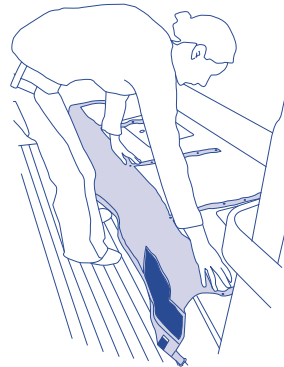

3 Choose a hole in the webbing closest to the front edge of the seat. Fix 5 x screw through the webbing.

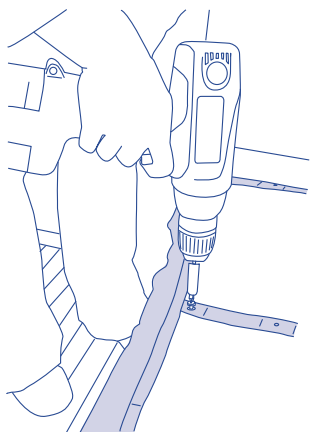

4 Cut the remainder of the webbing in between the stitching and dispose.

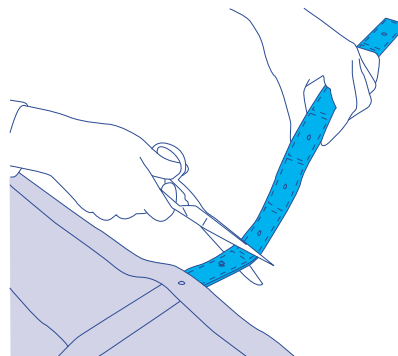

5 Make a connection from a fixed point on the boat to the D-rings fitted on the ends of the bunknet.

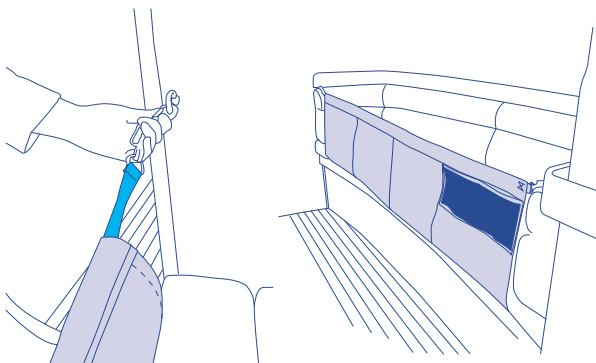

6 Stow away underneath the mattress when not used.

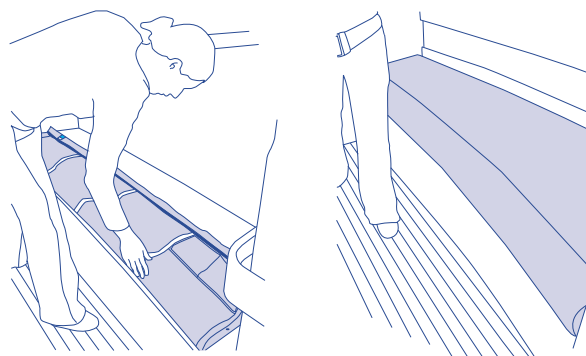

BLUE PERFORMANCE® IS A TRADEMARK OF BLUE PERFORMANCE BV®
ALL MODELS ARE REGISTERED



Blue Performance BV
Leimuiderdijk 478A
2156 MX Weteringbrug
The Netherlands
+31 71 331 33 66
+31 71 331 33 87
www.blueperformance.com
info@blueperformance.com